

FREE ENERGY GENERATION

THEN

**BEDINI'S FREE ENERGY GENERATOR**

by

John C. Bedini

*DMØd f, EUS`*

# FREE ENERGY GENERATION

## DEDICATION

To my Aunt Dorothy, and my wife, Rhonda Bedini. Without their support and encouragement, this agonizing effort would not have been possible.

## FREE ENERGY GENERATION

### FOREWORD

John Bedini has a prototype free energy motor.

Imagine having a small D.C. electrical motor sitting on your laboratory bench powered by a common 12-volt battery. Imagine starting with a fully charged battery and connecting it to the motor with no other power input. Obviously, the motor is going to run off the battery, but by conventional thinking it will stop when the battery runs down.

Impossible, you say. Not at all. That's precisely what John Bedini has done and the motor is running now in his workshop.

It isn't running by the conventional wisdom of electrical physics. It isn't running by the conventional rules of electric motors and generators, but it is running.

And it isn't something complex. It's pretty simple, once one gets the hang of the basic idea.

It's running off the principles of electromagnetics that Nikola Tesla discovered shortly before 1900 in his Colorado Springs experiments. It's running off the fact that empty vacuum - pure "emptiness," so to speak - is filled with rivers and oceans of seething energy, just as Nikola Tesla pointed out.

It's running off the fact that vacuum space-time itself is nothing but pure massless charge. That is, vacuum has a very high electrostatic scalar potential -

## FREE ENERGY GENERATION

it is greatly stressed. To usefully tap the enormous locked-in energy of that stress, all one has to do is crack it sharply and tap the vacuum oscillations that result. The best way to do that is to hit something resonant that is imbedded in the vacuum, then tap the resonant stress of the ringing of the vacuum itself.

In other words, we can ring something at its resonant frequency and, if that something is imbedded in the vacuum, we can tap off the resonance in vacuum stress, without tapping energy directly from the embedded system we rang into oscillation. So what we really need is something that is deeply imbedded in the vacuum, that is, something that can translate "vacuum" movement to "mass" movement.

Well, all charged particles and ions are already imbedded in the vacuum by their charged fluxes, so stressed oscillations - that is, vacuum oscillations - can be converted into normal energy of mass movement by charged particles or ions, if the system of charged particles or ions is made to resonate in phase with our tapping "potential." For our purpose, let's use a system of ions.

First we will need a big accumulator to hold a lot of the charged ions in the system that we wish to shock into oscillation. We need something that has a big capacitance and also contains a lot of ions.

An ordinary battery filled with electrolyte fits the bill nicely. While it's not commonly known, ordinary lead-acid storage batteries have a resonant ionic fre-

## FREE ENERGY GENERATION

quency, usually in the range of from 1-6 MHz. All we have to do is shock oscillate the ions in the electrolyte at their resonant frequency and time our "trigger" potential and "siphon" current correctly. Then if we keep adding potential to trigger the system, we can get all that "potential" to translate into "free electrical energy."

Look at it this way. Conventionally "electrostatic scalar potential" is composed of work or energy per coulomb of charged particle mass. So if we add potential alone, without the mass flow, to a system of oscillating charged particles, we add "physical energy" in the entire charged particle system. In other words, the "potential" we add is converted directly into "ordinary energy" by the imbedded ions in the system. And if we are clever we don't have to furnish any pushing energy to move pure potential around.

(For proof that this is possible, see Bearden's *Toward a New Electromagnetics; Part IV; Vectors and Mechanisms Clarified*; Tesla Book Co., 1983<sup>1</sup>, slide 19, page 43, and the accompanying write-up, pages 10-11. Also see Y. Aharonov and V. Bohm, "Significance of Electromagnetic Potentials in the Quantum Theory", *Physical Review*, Second Series, Vol. 115, No. 3, Aug. 1, 1959, pp. 485-491. On page 490 you will find that it's possible to have a field-free region of space, and still have the potential determine the physical properties of the system.)

<sup>1</sup> Available from The Tom Bearden website, [www.cheniere.org](http://www.cheniere.org)

## FREE ENERGY GENERATION

Now this "free energy resonant coupling" can be done in a simple, cheap system. You don't need big cyclotrons and huge laboratories to do it; you can do it with ordinary D.C. motors, batteries, controllers and trigger circuits.

And that's exactly what John Bedini has done. It's real. It works. It's running now on John's laboratory bench in prototype form.

But that's not all. John also is a humanitarian. He's as concerned as I am for that little old widow lady at the end of the lane, stretching her meager Social Security check as far as she can, shivering in the cold winter and not daring to turn up her furnace because she can't afford the frightful utility bills.

That's simply got to change and John Bedini may well be the fellow who changes it. By openly releasing his work in this paper, he is providing enough information for all the tinkerers and independent inventors around the world to have at it. If he can get a thousand of them to duplicate his device, it simply can't be suppressed as so many others have been.

So here it is. John has deliberately written his paper for the tinkerer and experimenter, not for the scientist. You must be careful, for the device is a little tricky to adjust in and synchronize all the resonances. You'll have to fiddle with it, but it will work. Keep at it.

Also, we warn you not to play with this unless you know what you are doing. The resonating battery elec-

## FREE ENERGY GENERATION

trolyte produces hydrogen, and if you hit it too hard with a voltage spike you can get an electrical spark inside the battery. If that happens, the battery will explode, so don't mess with it unless you are qualified and use the utmost caution.

But it does work. So all you experimenters and pioneers, now's your chance. Have at it. Build it. Tinker with it. Fiddle it into resonant operation. Then let's build this thing in quantity, sell it widely, and get those home utilities down to where we can all afford them - including the shivering little old lady at the end of the lane.

And when we do, let's give John Bedini, and inventors like him, the credit and appreciation they so richly deserve.

Tom Bearden

April 13, 1984

# FREE ENERGY GENERATION

## INTRODUCTION

One day a boy who plays with motors and generators gets a brilliant idea. He reasons with himself: "If I hook the motor to the generator via the same shaft, the generator should run the motor and vice versa." He soon discovers that many things are against him, so he devises better schemes and finds the same things again. (Summary of a *Time-Life* article on energy.)

However you may view this article, it does not count, because the principles on which our machine works are completely different. At this point, I will make reference to Tom Bearden's *Toward a New Electromagnetics; Part 4: Vectors and Mechanisms Clarified*, Tesla Book Co., 1983<sup>2</sup>. If you plan to build this machine, it is a must that you get Tom Bearden's paper. You will find on pages 20, 21 and 22 the description of a simple free energy motor. Also, you will find a block diagram on page 53, slide 40. Understanding the material in this paper is a must, or you may not succeed in building this simple free energy generator.

Special thanks is given to Tom Bearden for discussing a multitude of questions. Without him, this would not have been possible. Any errors made in this paper are my own and not the fault of others.

I must also state that neither John Bedini nor the publisher takes any responsibility for misuse of the

<sup>2</sup> Available from The Tom Bearden website, [www.cheniere.org](http://www.cheniere.org).



## FREE ENERGY GENERATION

information in the present paper due to bad hookups, misuse of the battery or faulty mechanical workmanship.

### BASIC CONCEPTS

For some time man has been looking for different ways to generate electricity. He has used water power, steam power, nuclear power and solar power. Recent papers written by Tom Bearden make a free energy generator possible. Tom Bearden, rather than patent his devices, chose to share them with people who had open ears. I myself have had numerous conversations with Tom Bearden. I found Tom to be one of the most reasonable men I have ever dealt with in this energy field. Most others would tell you stories of great machines they had, but would never present the truth with circuit diagrams or a look at the machine in question. Tom, on the other hand, clearly presents his ideas and discloses the concepts by means of which they work.

The facts I am about to present to you about free energy were never put into textbooks, only portions were. The textbooks have grounded people in conventional theory and made things very complicated. What I am about to explain is very simple; anyone can understand this theory and anyone who understands what he is doing can build this device.

I have been grounded in conventional theory for some eleven years. I have always tried to study the simplicity of electrical circuits, but my mind wouldn't allow

## FREE ENERGY GENERATION

this because of my orthodox training. In any event, I had to change the way I was looking at things. I started to wonder, why do we need to have things so complicated? The truth of the matter is, we have been taught to consume or waste energy at every turn in our lives, so we jump into our cars, turn on lights, etc. In other words, we have been conditioned to waste energy and fuels lavishly, not realizing that someday someone will sky-rocket our energy bills to a point where we will not be able to pay for these fuels. Everything will come to a stand-still.

But laugh as you will, at that time Rube Goldberg machines will power your future. It probably will not be uncommon to see machines from the size of garbage cans to the size of two story apartment houses powering everything in sight. These machines will be using a force in nature never conceived by the conventionally trained mind of today.

The theory I am about to explain to you will bring you one step closer to gaining free energy.

To begin my story, I must state that I had a vision: looking for this energy. Many times I hammered my head into the ground, but I refused to give up in my search. Any person with a dream should never let it be wasted by fools, who will always say "you can't do that". All that statement really means is that they do not know how to do it.

There are many different ways to explain this theory. I will discuss the first one now.

## FREE ENERGY GENERATION

The device is very simple and uses electronic circuits. Basically we drive a direct current motor with pulsed current from a battery, then utilize a special means to cause the battery to recharge itself.

First, the battery is connected to a simple flip-flop circuit which in turn drives a simple amplifier circuit. The load (motor) is connected to Q4 (2N5885, Figure 3), or between the positive pole of the battery and the collector of the output power transistor. As the motor starts moving forward, the load condition is decreased and the motor draws very little electrical energy. As the energy drawn from the battery is decreased, the flip-flop circuit goes faster and faster to a certain point, which determines the speed of the circuit; however, we can vary the speed by adding certain things that are also simple. The idea is to pulse the motor in a certain time frame, drive a flywheel of some mass, and convert the mass's angular momentum to energy for our use, giving back to the battery all we have robbed from it during one power pulse plus adding a little bit more.

An easy way to look at this is to say the battery is 12 volts. To charge this battery we need at least 2 volts over the battery voltage, so we need 14 volts applied in the correct direction. (See Figure 1.)

# FREE ENERGY GENERATION

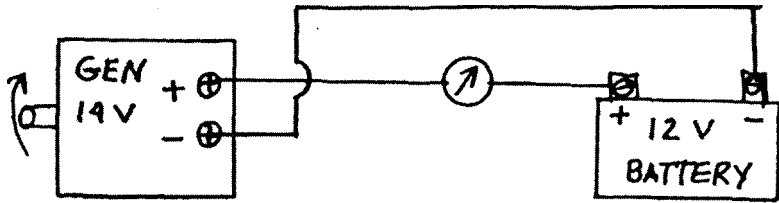

Figure 1. Recharging a Battery from a Generator

Looking at Figure 1 we can see that the generator is at 14 volts and the battery is at 12 volts so we have a reverse flow condition in the battery, which means the battery is in a charging condition. If, however, the generator did not make 14 volts but say only made 10.5 volts, the generator would act like a motor and just drain the battery away and the current meter would show discharge.

So far, this is all just conventional theory on how batteries are charged, and this is all you will find in textbooks, except for some books that tell you how to make special power supplies to charge batteries faster. With the machine I am going to describe to you, we will do better than that; we can actually boil the battery away if the device is not properly constructed.

Let's begin by stating certain facts. The ions move backwards under charging conditions and in reverse under discharging conditions. So here we start our new concept. Suppose we have constructed a machine that has tricked this battery into a different space and time relationship. Simply put, suppose the battery never did

## FREE ENERGY GENERATION

any work and it should have its full charge left in it. Suppose this becomes possible because we have stressed the terminals in such a way that the ions in the battery electrolyte actually move themselves backwards. The machine, or unit, that makes this possible has many different names. Some people call these units generators, energizers, alternators, etc. Conventionally such devices have one thing in common; they stress the battery backwards by pushing electricity to the battery and forcibly pushing the ions in the electrolyte backwards. In our theory we are not going to push anything - the ions are going to move themselves, recharging the battery.

If we go a little deeper into this theory, you are probably asking yourself "What is this madman talking about?" Simply put, we are going to put a stress on the battery terminals for a moment in time and the battery will do the rest.

Now comes the heavy part of this theory. What they didn't teach you in textbooks is that, in order for the battery to charge, two oscillatory actions must occur, one at the positive terminal and one at the negative terminal. Under different stress levels this then forces the ions backwards. The same would occur for an electron. Our machine will slingshot ions in the battery electrolyte backwards beyond the normal recoil action. (See Figure 2.)

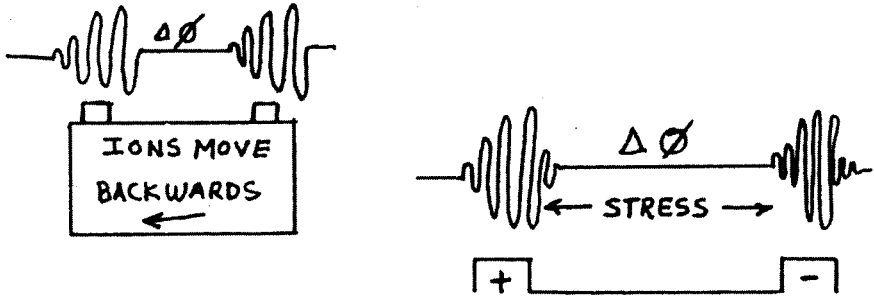

Figure 2. Ringing of Ions in the Battery from a Hammer Effect

I must give a very stern warning at this time that if the voltage developed is too high the battery will explode. Use the utmost care. Test setups in my lab have proven that this can be dangerous. Do not build the device and experiment with it unless you know what you are doing, and use the utmost caution.

When struck by a sharp voltage spike, the electrolyte in the battery will resonate at a certain frequency and this can also force the ions backwards. Simply put, the battery, the motor and the energizer will become resonant at some point, "ring" like a bell when we "strike" it, and in its ringing the most energy will be developed.

#### THE CONTROL CIRCUIT

For people who like to tinker and like electronics, these are the circuits I have used in my lab to examine this new concept.

## FREE ENERGY GENERATION

The circuit contains a very simple, free-running multivibrator circuit which is used to gate the operation of a two stage amplifier.

A motor or other load is connected in series with the collector of the output transistor, and each time the transistor conducts voltage, it will be applied across the load.

The input power may be any D.C. voltage from 6 to 24 volts.

The rectangular wave developed at the collector of the second transistor is resistively coupled to the base of the 2N5875, gating it on and off. This stage in turn gates the operation of the 2N5885 used in the output stage.

A motor is connected from the positive side of the battery to the collector of the output transistor. The motor pulses at the frequency of the multivibrator.

(See Figure 3 page 19.)

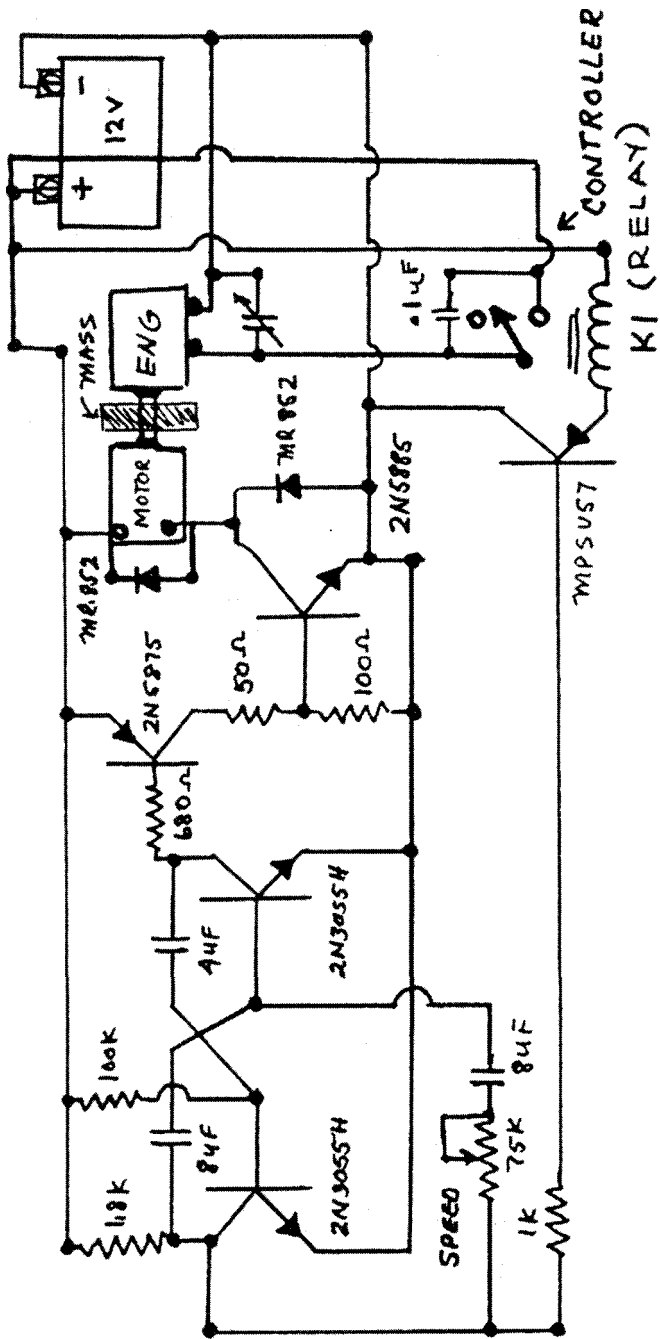

Figure 3. Circuit for the Bedini Free Energy Device



## FREE ENERGY GENERATION

In Figure 3 it must be remembered that the tuning of the circuit is very important in that the pulser circuit must be out of phase with the controller circuit. Those persons who have instruments to check this must connect the probes of an oscilloscope on channel A to the collector of the 2N5885 and ground the scope to channel B which must be across the battery. The wave forms should look like those shown in Figure 4.

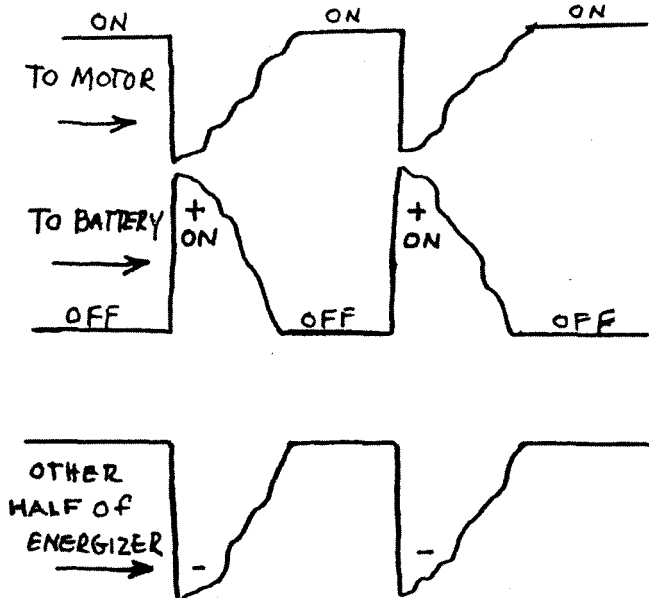

Figure 4. Oscilloscope Wave Form

In studying this new concept a little further, we see that something very unconventional is taking place here. The motor is very conventional as far as pulsed waveforms go, but the energizer is doing something very unusual. The waveforms from the energizer are telling us a new story. If we take the scope and expand these

## FREE ENERGY GENERATION

waveforms out even further, around 50 MHz, the waveforms look completely different. (See Figure 5.)

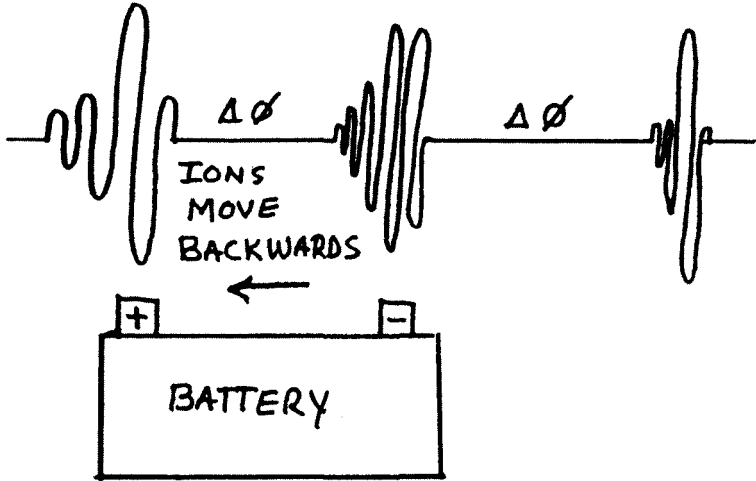

Figure 5. Stimulated Resonance Provides Self-Charging

As we look at Figure 5 the story becomes clear. The battery is really charging itself. The ions in the electrolyte are being stressed in a curved space and time relationship; the battery is actually forced into believing that no work ever occurred. The oscillatory action that has taken place by the energizer has just pulsed our "slingshot" back and immediately let go. Once this has happened, the electrolyte in the battery goes wild and the ions race backwards, giving off hydrogen and oxygen gas.

I must make a stern warning here! The time of the stimulating pulse is very important. If the time is too long, the battery will burn itself out. If the pulse

## FREE ENERGY GENERATION

time is too short or if the circuit fails to operate correctly, the battery will never recover its charge.

Taking this into consideration, the only failures that could occur would be the controller failing to operate due to a points failure, or the multivibrator latched in the "on" position. Anyone studying this can see that we have used very little energy to get to this point, and gained a lot of resonant energy in return.

We must remember that, if the battery is applied to the energizer longer than normal, we must burn up the excess energy to keep the battery cool. The problem becomes one of embarrassing excess of energy, not a shortage.

Now I have one question for you, what will you do with the excess energy and where did you get it?

### THE ENERGIZER

The energizer is also a simple machine, but if you want to, you can make it very complex. The simple way is to study the alternator principles. The waves we want to generate are like those that come from old D.C. generators with the exception of armature drag, bearing drag and no excited fields. Also, we would want to cut the magnetic fields at 90 degrees to the armature. The simpler the better.

I am going to throw a few ideas your way. I have run some tests in my lab and discovered that certain types of energizers, generators and alternators do what we

## FREE ENERGY GENERATION

need. Also, we want to be able to tune the output of our energizer. The old D.C. generator puts out something very close to what we need, except for the drag. (See Figure 6.)

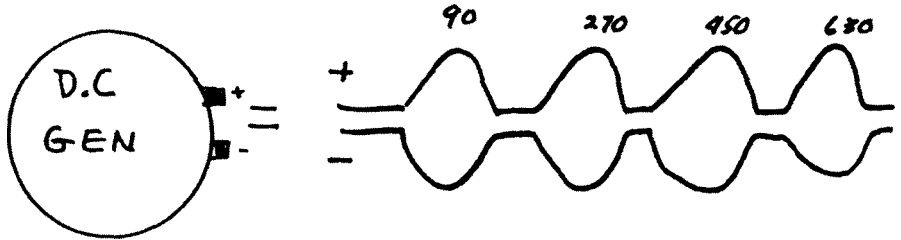

Figure 6. Output Pulses from a D.C. Generator

Looking at Figure 6, this is pulsed D.C. and everybody will accept this, except me, because the other half has been left out *once* again. It is the same old story, wasting energy. Conventionally it is not important to know about the other half. Well, it is very important to me, because I need it to build my energizer.

The D.C. generator output actually looks like this when expanded. (See Figure 7.)

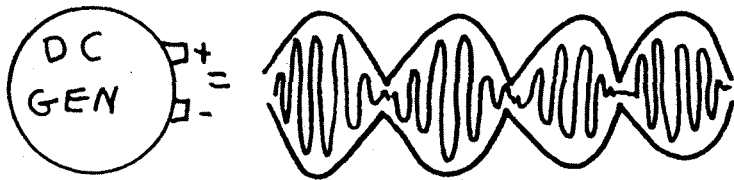

Figure 7. Expanded Output from a D.C. Generator

In an A.C. generator output we are going to see just what we manufactured. (See Figure 8.)

# FREE ENERGY GENERATION

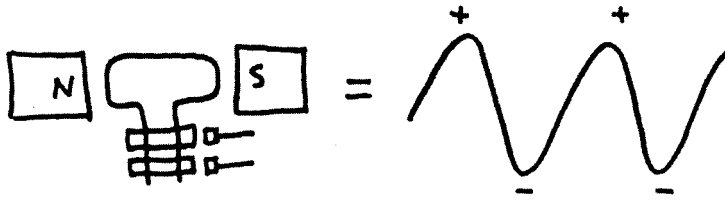

Figure 8. A.C. Generator Output

It would appear that this leaves this generator out. Not really, because we can make this generator's output change by rectifying it. (See Figure 9.)

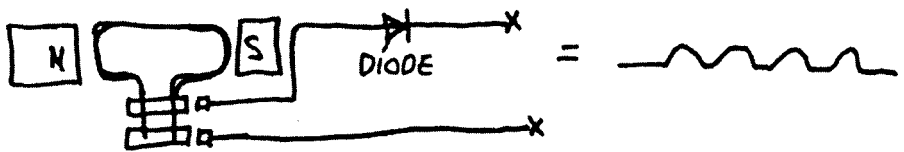

Figure 9. Rectified Output from an A.C. Generator

In looking at the A.C. generator with rectified output, we see that it could become very useful to us as an energizer, simply because it is the easiest to construct and its principles are simple. I have done experiments with a little different variation of this machine, as shown in Figure 10.

FREE ENERGY GENERATION

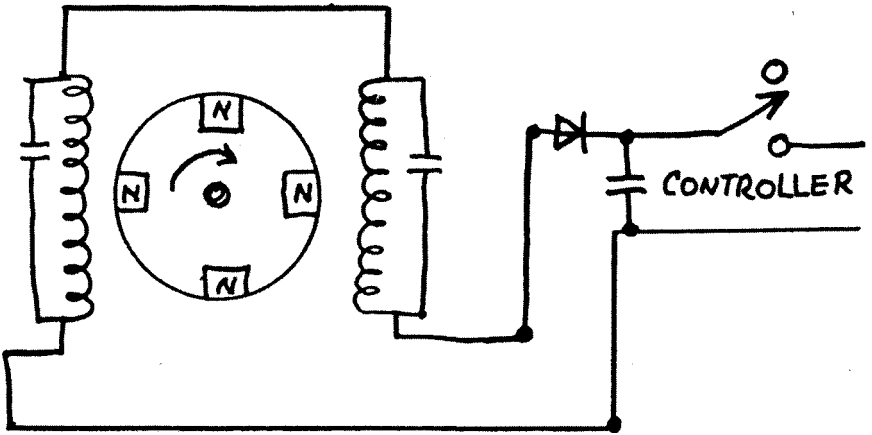

Figure 10. Variation of a Rectified A.C. Generator

According to the conventional books, this alternator principle applies this way, as shown in Figure 11.

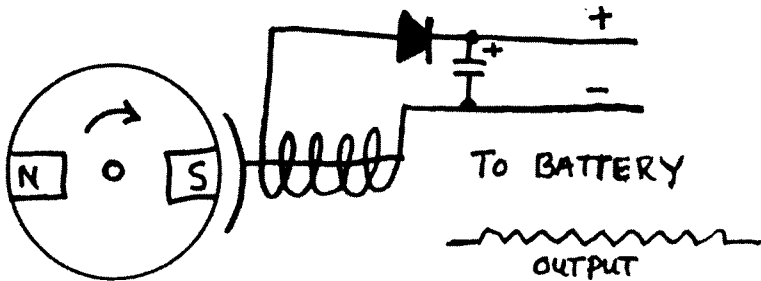

Figure 11. Conventional Explanation

In Figure 10 most people can see that the alternator drawn here might have some problems. However, remember that I am looking for a certain type of wave form that I want to tune to a certain frequency at a certain speed. The winding of this alternator is a problem and it is

## FREE ENERGY GENERATION

tricky, but I chose to stay with this unit. You may choose a different method if you retain the principle.

### THE CONTROLLER

The controller is a simple piece of equipment to build; however the controller in Figure 3 could present certain problems if the contacts or points were to arc closed. If this were to happen, the motor soon would drain the energy from the battery and things would die.

There is another type of controller I must make known, and it is the simplest of all. With three brushes and a commutator, you can do away with all the electronics and handle 100 times the power back to the battery. The simplest method would be a split commutator, of which a little less than 180 degrees would be copper. (See Figure 12.)

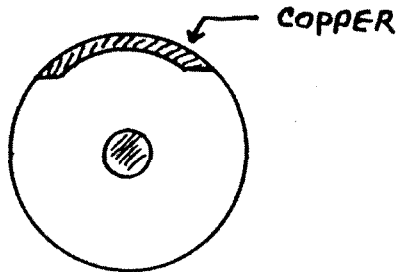

Figure 12. Split Commutator

This split commutator is going to become our pulser and our controller, doing away with all the electronics. Just think - no transistors to fail, no relays to stick, no resistors to burn up and the best of all - no cost!

## FREE ENERGY GENERATION

The only thing this unit requires is a little tinkering and later on you can add the vacuum advance.

But enough joking around! The next step is to build a good unit that will last a long time. You may choose to build any other version you wish. Now, we need three 12 brushes and you can begin to see how this is going to work for us. (See Figure 13.)

Figure 13. Split Commutator with 3 Brushes

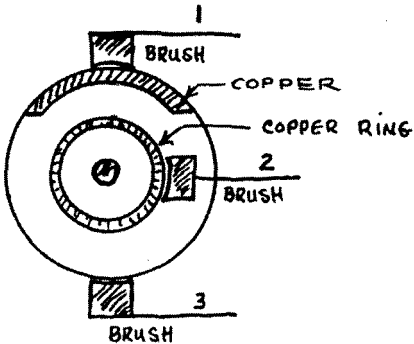

Figure 13a.

Physical Construction

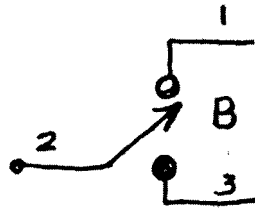

Figure 13b.

Equivalent Circuit

As we can see, the physical construction (Figure 13A) is nothing more than a simple switch (illustrated in Figure 13B). The thing to remember is that this commutator is completely insulated from the shaft; otherwise the bearings will arc in the motor and the heavy mass, or flywheel, will chew the bearings up. This controller only has one function - to gate the energy from the



## FREE ENERGY GENERATION

battery and to return it in the opposite direction. You have already seen the wave forms earlier in this paper.

There may be some tinkering around to be done with brush 1 or brush 3, depending on which way you want to hook it up. Also, once again, the timing between brush 1 and brush 3 is very important.

Let's look at the way this would be hooked up. (See Figure 14 on page 28).

If you hook up the components as shown and tinker with it until you get a stimulated resonance-coupled system, you will have a free running motor that powers itself and performs useful external work as well.

I think I have presented the facts as they really are. The machine is simple and not complicated. If built and adjusted correctly, this unit should supply energy for whatever you need.

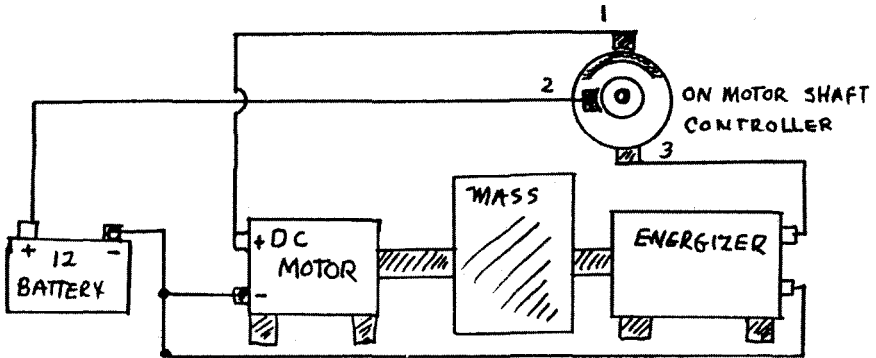

Figure 14. Prototype Hookup

## FREE ENERGY GENERATION

A photo of a prototype is shown in Figure 15 on 31 and on page 32 is a diagram of the device I am now building as the second phase of this development.

The devices shown are my original concepts, of which I have actually built several working models. These have been witnessed by reliable observers. Several of these units are being constructed by friends and acquaintances, based on my instructions.

For those who wish to build and make improvements in the units described, the very best of luck to you. I am willing to offer suggestions to those who are truly involved and need some assistance.

A handwritten signature in cursive script that reads "John C. Bedini".

John C. Bedini April 9, 1984

## FREE ENERGY GENERATION

### CONSTRUCTION NOTES

For those interested in building and experimenting with a free energy unit, a brief description of the basic components used in the original prototype is as follows:

MOTOR - G.E. permanent magnet, 1100 RPM, 1/12 h.p. This motor draws approx. 10 amps on pulses on start-up. As the speed of the motor increases, the amperage will decrease to about 1 amp on pulses. Permanent magnet motors are suggested based on good efficiency.

BATTERY - 12 volt, 12 amp-hour motorcycle battery.

ENERGIZER - A standard office type 2-speed A.C. fan was used for the housing. The coils were replaced with 6 coils of approx. 200 turns of #20 wire - all in phase. Six permanent magnets are bonded to an aluminum disc. The arrangement should be similar to that shown in Figure 16a/16b. This arrangement is basically a magneto, but will produce more amperage than ordinarily expected of a magneto.

CONTROLLER - If the controller as shown in Figure 13 is used, it is important that provision be made to rotate the brushes in relationship to each other in order to secure the required timing.

The author again wishes to stress the fact that while the circuit and apparatus is not complicated, a great deal of "tinkering" may be required to obtain efficient operation. Much is yet to be discovered in the con-

## FREE ENERGY GENERATION

struction and operation of such a unit, but the first major step has been made.

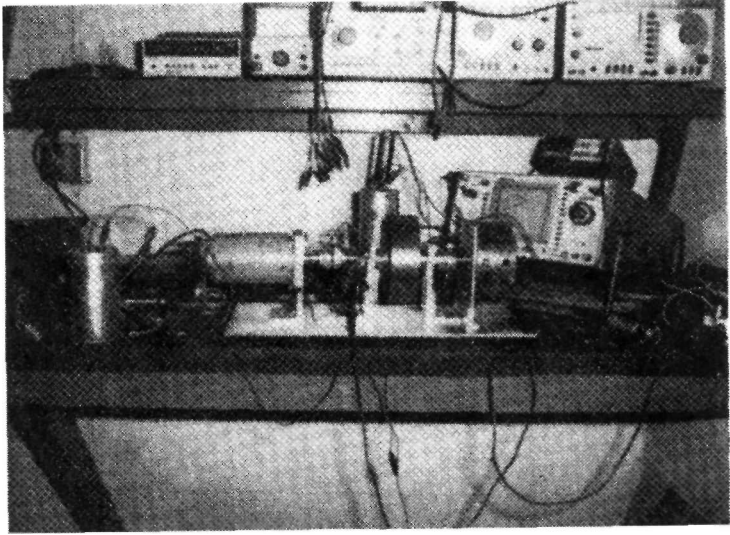

Figure 15. Prototype of Free Energy Unit

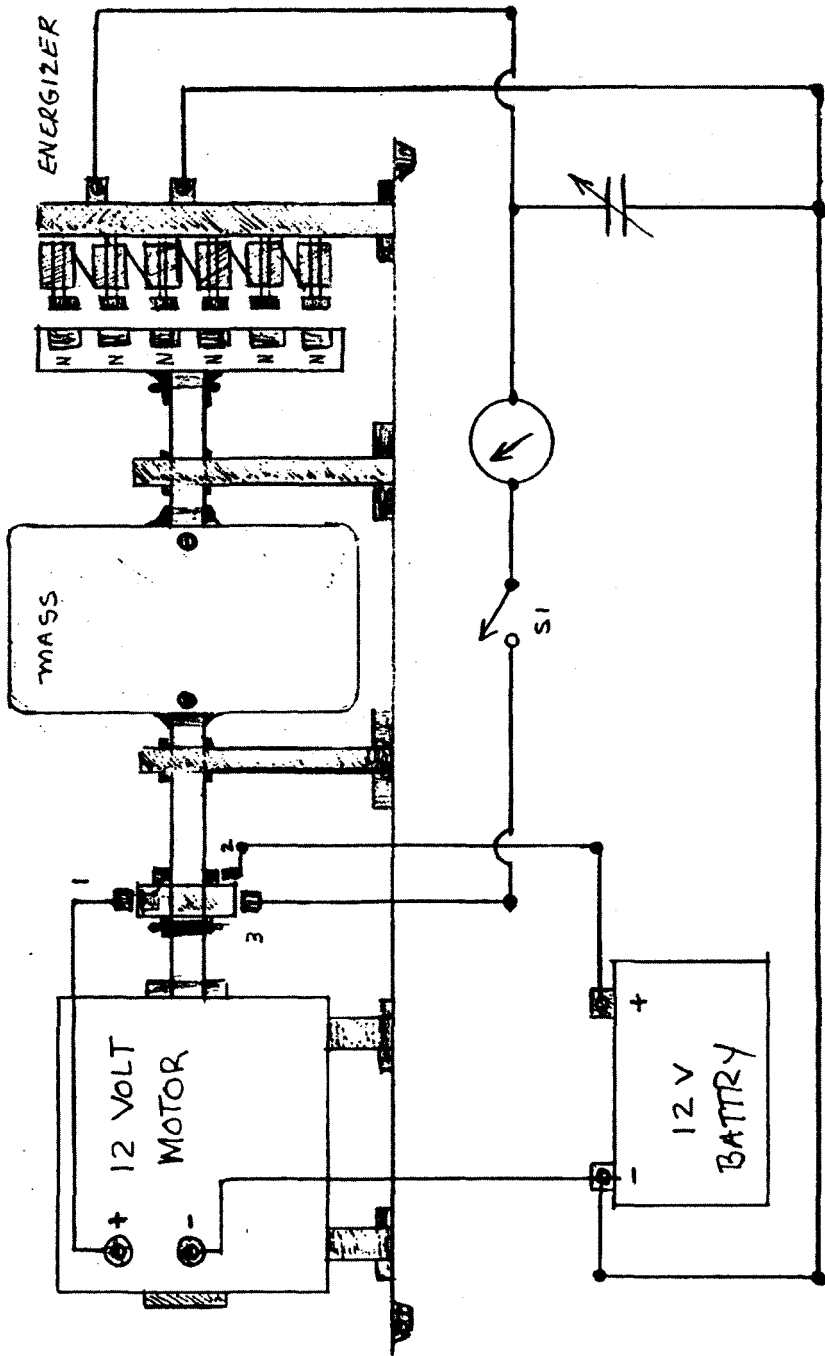
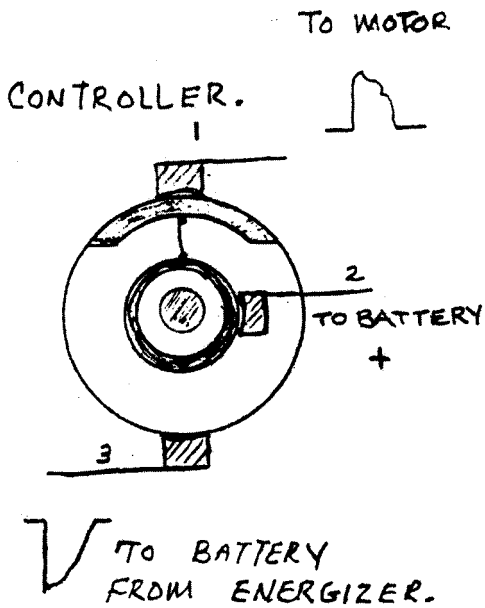

Figure 16a. Bedini's Test Model No. 2

FREE ENERGY GENERATION



Patent Pending

Figure 16b. Bedini's Test Model No. 2 (Controller)